

INSTALLATION INSTRUCTIONS



IMPORTANT

Before opening your Lights.com fixture, please make sure that you carefully read through these instruction sheets. Consider having your fixture installed by a qualified licensed electrician.

NOTE: The important safeguards and instructions that appear in this manual are not meant to cover all possible conditions and situations that may occur. It must be understood that common sense, caution and care, are factors that can't be built into any product. This approach must be used by the person(s) caring for and operating the fixture.

GENERAL INFORMATION

All electrical connections must be in accordance with all ordinances, Local and National Electrical Codes. These fixtures are intended for mounting to a standard 4" x 2-1/2" metal octagon box. The box must be directly supported by the building structure and U.L. Recognized.

STEP BY STEP INSTRUCTIONS

Before starting your installation, disconnect the power by turning off the circuit breaker or by removing the fuse at the fuse box. Just turning the light off at the light switch is not sufficient to prevent electrical shock.

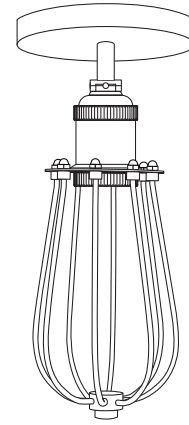

COLLECTION

Alton

APPLICATION

Flush Mount

MODEL NO.

LC004424
LC004429
LC004434
LC004439

WHAT WE PROVIDE

- Alton Flush Mount
- Wire Nuts and Mounting Hardware
- Raindrop Cage

WHAT YOU NEED

- Phillips Head Screwdriver
- Wire Cutters
- Wiring Supplies as Specified by Electrical Code
- 1 x 60W E26 Bulb
- Electrical Tape

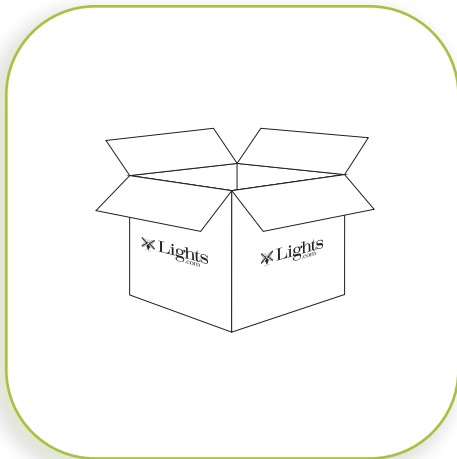

1

UNPACK YOUR FIXTURE

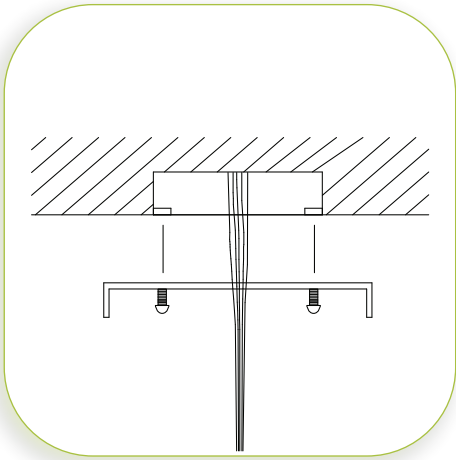

2

PREPARE FIXTURE AND INSTALL MOUNTING PLATE

If there is an existing fixture, remove it. Expose the supply wires from the J-box. Insert supply wires through the mounting plate. Secure mounting plate using the two Phillips head screws provided. Hand tighten to secure.

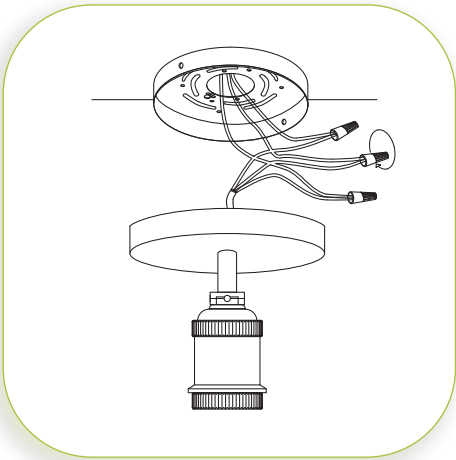

3

MAKE WIRE CONNECTIONS

Connect BLACK fixture wire to the BLACK supply wire and WHITE fixture wire to the WHITE supply wire. Connect the fixture GROUND wire to the J-Box GROUND wire or wrap around one of the protruding screws on the mounting plate. Secure all connections with the supplied wire nuts, secure all wire connections with electrical tape (not supplied). Tuck all wires carefully into the J-Box.

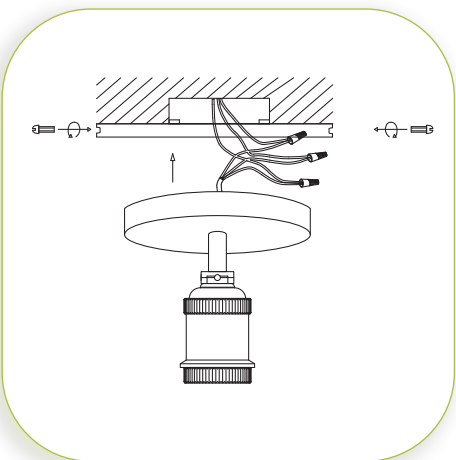

4

INSTALL FIXTURE TO THE MOUNTING PLATE

Position canopy over the mounting plate. Align the holes on the mounting plate with the holes on the side of canopy and secure with the supplied screws.

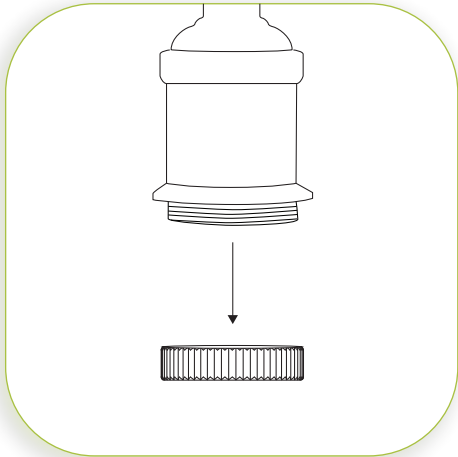

5

REMOVING DECORATIVE RING

Remove the decorative ring from the socket.

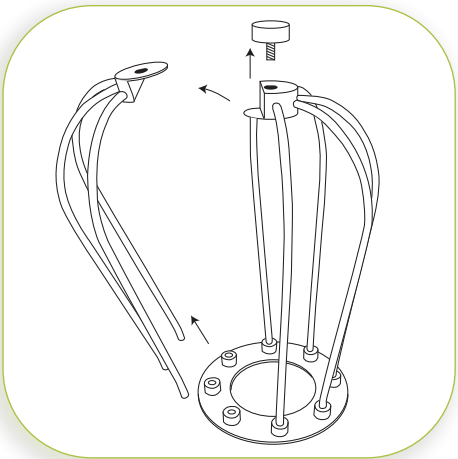

6

OPENING CAGE

Open cage by unscrewing the decorative nut located on the bottom. This will detach the partial cage section from the cage base.

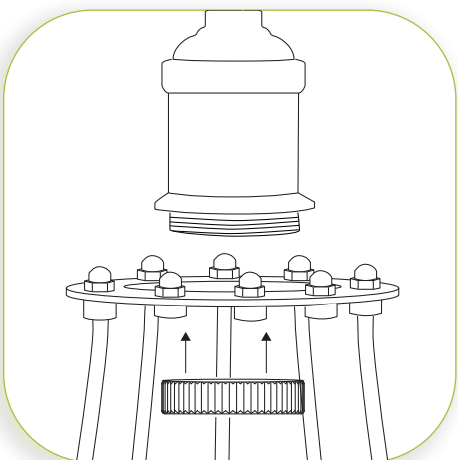

7

ATTACHING CAGE

Attach cage base to the socket and secure in place with socket ring.

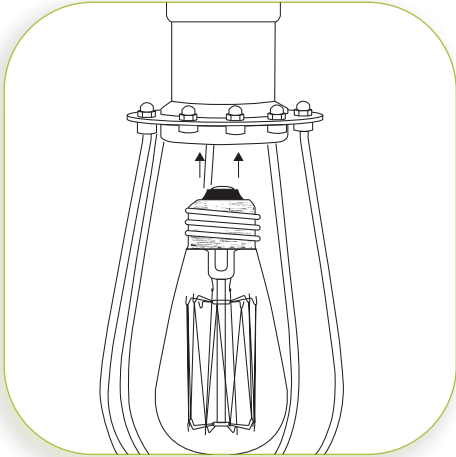

8

INSTALL BULB

Install the bulb. MAXIMUM WATTAGE 60W.

DO NOT EXCEED THE WATTAGE AS STATED ON THE WARNING LABEL.

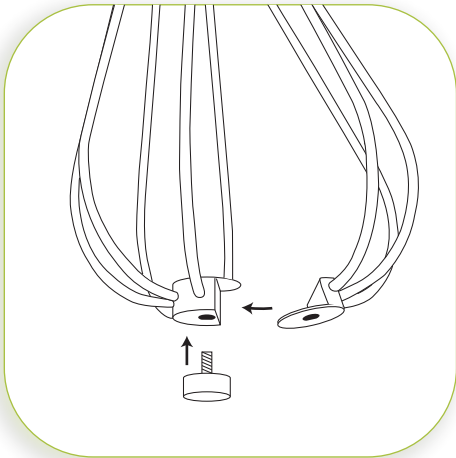

9

SECURE CAGE BARS

Reattach the removed partial cage section into cage base and secure with nut.



10

RESTORE THE ELECTRICITY AND CHECK THE OPERATION OF YOUR NEW FIXTURE

CAUTION

Please ensure that the fitting is cool and switched off before replacing the bulb. DO NOT use bulbs that might exceed the maximum wattage, stated on caution label.

DIMMER NOTE

Note: For the best lighting experience, we recommend using a dimmer. Not only does this allow you to create a great ambiance, it allows for energy savings and extends the life of the bulb.