

INSTALLATION INSTRUCTIONS



IMPORTANT

Before installing your Lights.com fixture, please make sure that you carefully read through these instruction sheets. Consider having your fixture installed by a qualified licensed electrician.

NOTE: The important safeguards and instructions that appear in this manual are not meant to cover all possible conditions and situations that may occur. It must be understood that common sense, caution and care, are factors that can't be built into any product. This approach must be used by the person(s) caring for and operating the fixture.

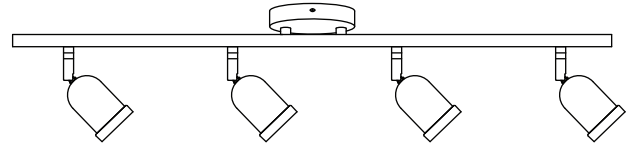

COLLECTION

Bixby

APPLICATION

Fixed Track

MODEL NO.

LC004991

GENERAL INFORMATION

All electrical connections must be made in accordance with all ordinances, and local and national electrical codes. These fixtures are intended for mounting to a standard 4" junction box. The box must be directly supported by the building structure and be ETL or U.L. Recognized.

STEP BY STEP INSTRUCTIONS

Before starting your installation disconnect the power by turning off the circuit breaker or by removing the fuse at the fuse box. **Just turning the light off at the light switch is not sufficient to prevent electrical shock.**

WHAT WE PROVIDE

- 32" 4-Light Fixed Track
- Mounting & Wiring Hardware
- 4 x GU10 Bulbs
- 1 suction cup

WHAT YOU NEED

- Phillips head Screwdriver
- Wire Cutters
- Wiring Supplies as Specified by Electrical Code
- Electrical Tape

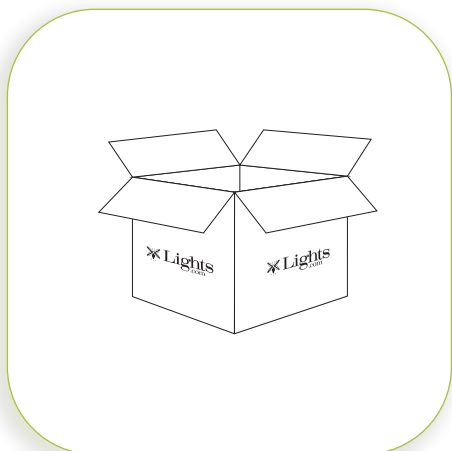

1

UNPACK YOUR FIXTURE

INSTALLATION INSTRUCTIONS

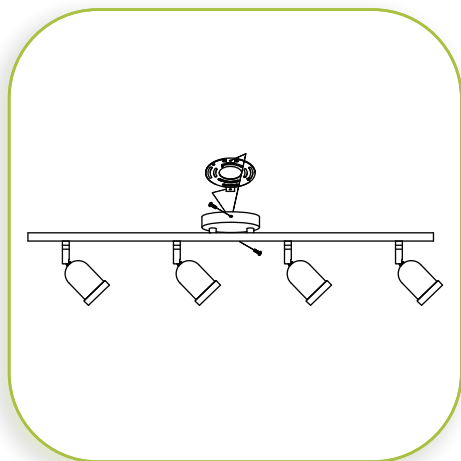

2

PREPARE FIXTURE AND MOUNTING PLATE

Remove the mounting plate from the backplate by unscrewing the screws from the backplate.

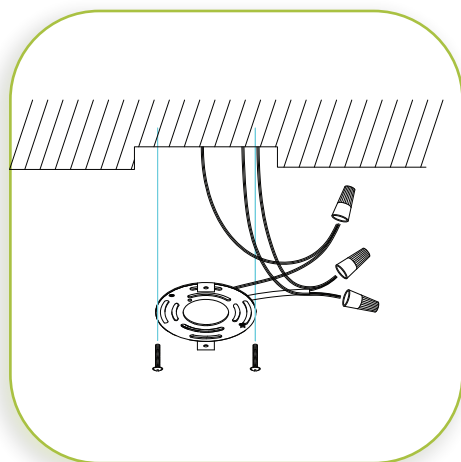

3

INSTALL THE MOUNTING PLATE

Note: This fixture can be mounted horizontal or vertical.

If there is an existing fixture, remove it. Expose the supply wires from the J-Box. Insert supply wires through the mounting plate. Secure the mounting plate using the Phillips head screws provided. Tighten to secure.

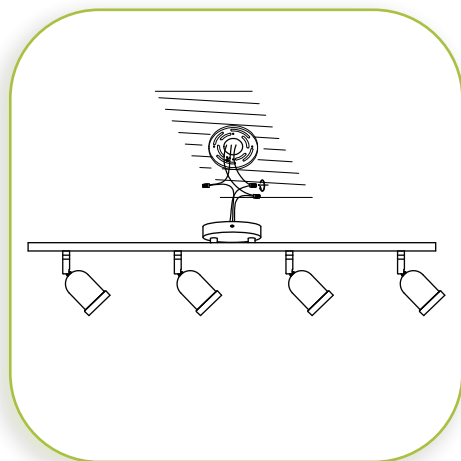

4

MAKE WIRE CONNECTIONS

Connect the BLACK fixture wire to the BLACK supply wire and the WHITE fixture wire to the WHITE supply wire.

Connect the fixture ground wire to the J-BOX ground wire or wrap around one of the protruding screws on the mounting plate. Secure all connections with the supplied wire nuts and electrical tape (not supplied).

INSTALLATION INSTRUCTIONS

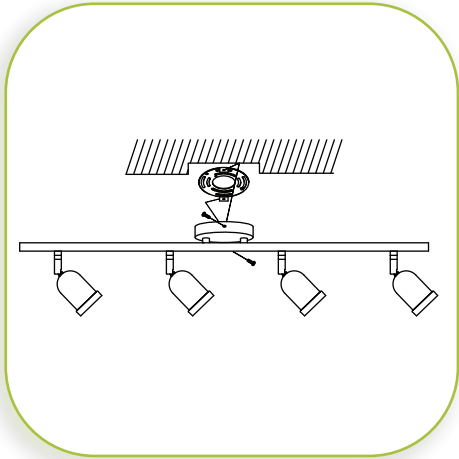

5

CONNECT FIXTURE TO THE MOUNTING PLATE

Position backplate over the mounting plate. Align the holes on the sides of the mounting plate with the two holes on the sides of the backplate and secure with the supplied screws.

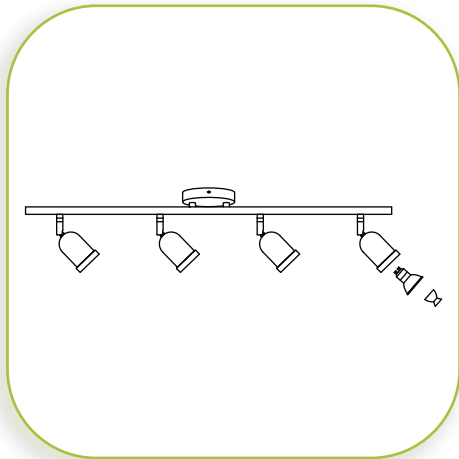

6

INSTALL THE BULB

The bulb socket has two bumps that correspond with the two holes inside the socket. Push the suction cup on the front glass of the bulb, ensuring you have a tight connection. Line up the two bumps on the bulb with the two holes in the socket. Once inserted turn clockwise holding the end of the suction cup until you feel the bulb lock in. This is about a quarter turn. Repeat this process for the other bulbs until all are installed.

MAXIMUM WATTAGE 25W. DO NOT EXCEED THE WATTAGE AS STATED ON THE WARNING LABEL.

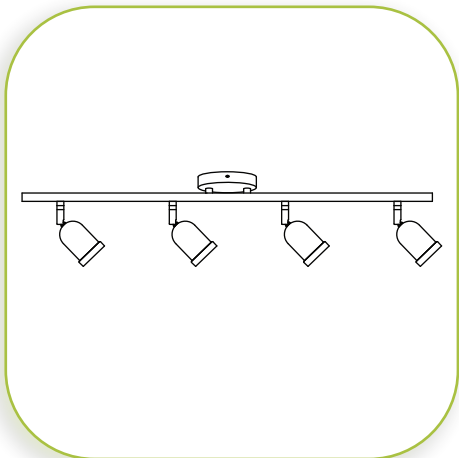

7

RESTORE THE ELECTRICITY AND CHECK THE OPERATION OF YOUR NEW FIXTURE



DIMMER NOTE

For the best lighting experience, we recommend using a dimmer. Not only does this allow you to create a great ambiance, it allows for energy savings and extends the life of the bulbs.