

INSTALLATION INSTRUCTIONS



IMPORTANT

Before opening your Lights.com fixture, please make sure that you carefully read through these instruction sheets. Consider having your fixture installed by a qualified licensed electrician.

NOTE: The important safeguards and instructions that appear in this manual are not meant to cover all possible conditions and situations that may occur. It must be understood that common sense, caution and care, are factors that can't be built into any product. This approach must be used by the person(s) caring for and operating the fixture.

GENERAL INFORMATION

All electrical connections must be in accordance with all ordinances, Local and National Electrical Codes. These fixtures are intended for mounting to a standard 4" x 2-1/2" metal octagon box. The box must be directly supported by the building structure and U.L. Recognized.

STEP BY STEP INSTRUCTIONS

Before starting your installation, disconnect the power by turning off the circuit breaker or by removing the fuse at the fuse box. Just turning the light off at the light switch is not sufficient to prevent electrical shock.

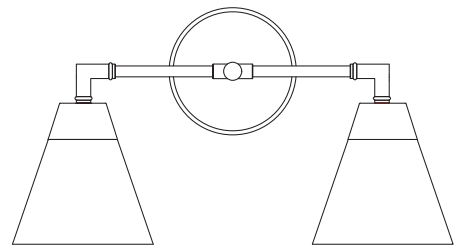

COLLECTION

Owen

APPLICATION

2-Light Vanity Light

MODEL NO.

LC005165

LC005166

LC005167

WHAT WE PROVIDE

- Vanity Light
- Mounting & Wiring Hardware
- 2 Glass Shades

WHAT YOU NEED

- Phillips head Screwdriver
- Wire Cutters
- Wiring Supplies as Specified by Electrical Code
- 2x 60W E26 Bulb
- Electrical Tape



1

UNPACK FIXTURE

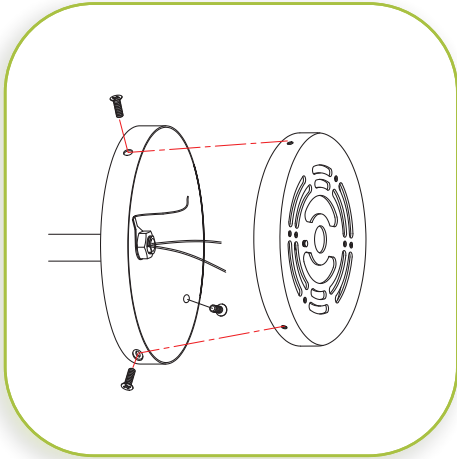

2

PREPARE FIXTURE AND MOUNTING PLATE

Remove the mounting plate from the backplate by unscrewing the three phillips head screws from the side of the backplate



3

INSTALL THE MOUNTING PLATE

NOTE: This fixture can be mounted with the glass up or down. So make sure to align the holes in the backplate according to the way you want the glass mounted.

If there is an existing fixture, remove it. Expose the supply wires from the J-Box. Insert the supply wires through the mounting plate. Secure the mounting plate to the J-Box using the phillips head screws provided. Tighten to secure.

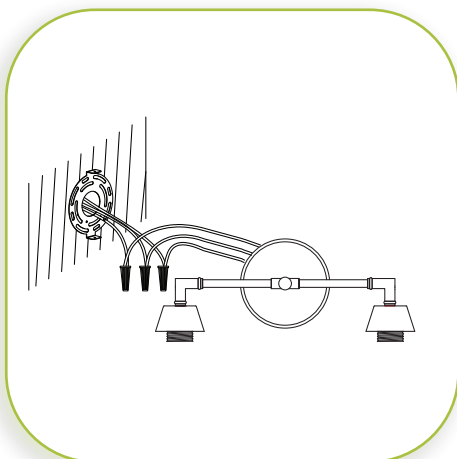

4

MAKE WIRE CONNECTIONS

Connect the BLACK fixture wire to the BLACK supply wire. Then connect the WHITE fixture wire to the WHITE supply wire. Finally connect the fixture ground wire to the J-Box ground wire or wrap around one of the protruding screws on the mounting plate. Secure all connections with the supplied wire nuts followed by electrical tape (not supplied).

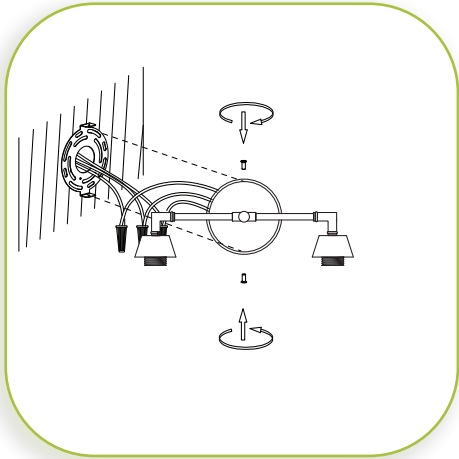

5

CONNECT FIXTURE TO THE MOUNTING PLATE

****Remember glass can be mounted up or down.**

Position the backplate over the mounting plate. Align the three holes on the mounting plate with the three holes in the backplate. Secure with the decorative phillips head screws that were removed in Step 2. Hand tighten until secure.

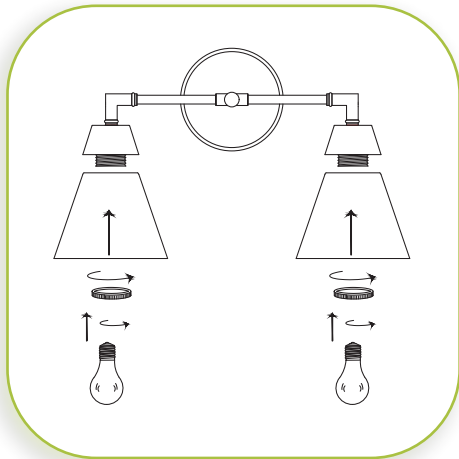

6

INSTALL SHADES AND BULBS

Remove the socket ring from the socket. Hold the glass shade up to the socket and secure with the socket ring.

Install the bulbs. **MAXIMUM WATTAGE 60W.**

DO NOT EXCEED THE WATTAGE AS STATED ON THE WARNING LABEL.

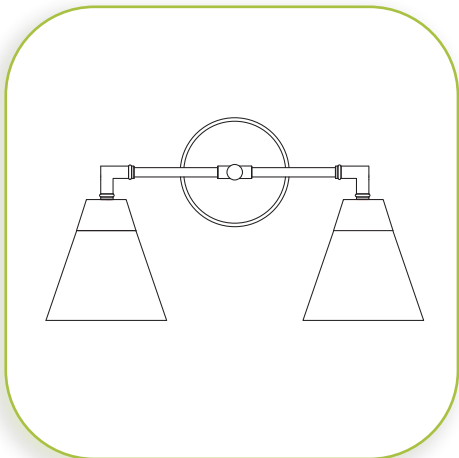

7

RESTORE THE ELECTRICITY AND CHECK THE OPERATION OF YOUR NEW FIXTURE



DIMMER NOTE

For the best lighting experience, we recommend using a dimmer. Not only does this allow you to create a great ambiance, it allows for energy savings and extends the life of the bulbs.